

# MERLIN

## WIRELESS

## INSTALLATION

THIS MANUAL IS DESIGNED TO LEAD YOU STEP BY STEP THROUGH THE PROCEDURES REQUIRED TO TEST, INSTALL AND USE YOUR WIRELESS MERLIN. BY FOLLOWING THESE PROCEDURES AND SETTING UP THE SYSTEM CORRECTLY IN THE BEGINNING, YOU WILL BE ABLE TO ENJOY ALL THE FEATURES OF YOUR WIRELESS MERLIN FOR YEARS TO COME. WE STRONGLY SUGGEST THAT YOU PERFORM A TRIAL WIRING OF YOUR WIRELESS MERLIN PRIOR TO FINAL INSTALLATION.

Locate the **NiCad** Batteries and Battery charger, then charge the batteries according to the charger instructions. You will need them later. The **NiCad** batteries will be kept charged by the solar panel when installed in the transmitter. They should not need replacement for two to three years. When they do need replacement use 1000 milliamp/hour **NiCad** batteries. (Do **NOT** use Alkaline or NiMH batteries.)

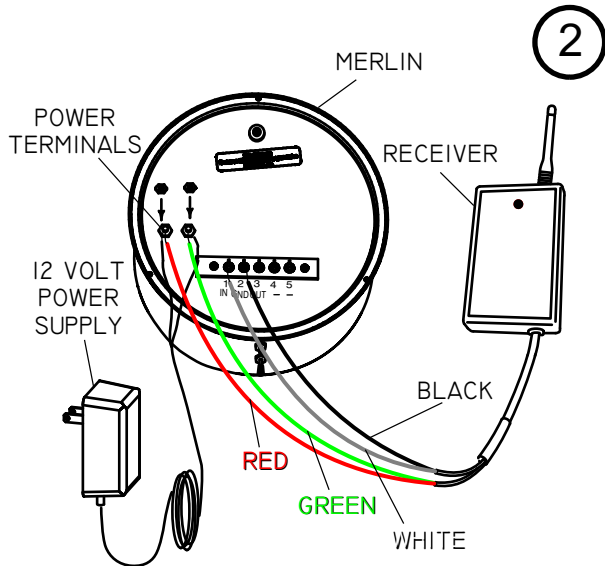
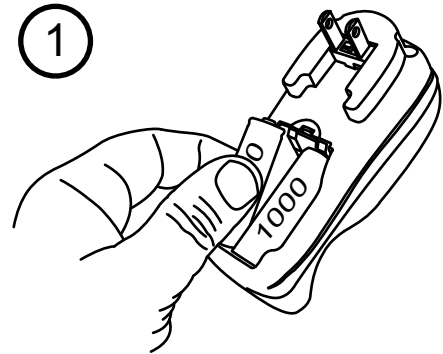

**2** You now need to wire your receiver to your display unit. Connect the **RED** and **GREEN** wires from the RECEIVER to the power terminals on the back of the MERLIN (the polarity does not matter). Connect the wires from the 12 volt power supply to the same power terminals (again the polarity does not matter). Connect the **WHITE** wire from the RECEIVER to TERMINAL #1 and the **BLACK** wire from the RECEIVER to TERMINAL #2 on the rear of the MERLIN indicator.

RECEIVER WIRING	
WHITE	.....to.....TERMINAL #1
BLACK	.....to.....TERMINAL #2
RED	.....to.....Power (no polarity)
GREEN	.....to.....Power (no polarity)

Feed the **YELLOW** and **BROWN** wires from the Wireless Wind Transmitter through the small access hole in one of the black rubber boots. Using the solid brass nuts from the Hardware Pack, attach the wires to the two terminals on the Wind Speed Sensor (no polarity). Do **NOT** adjust the nuts that are already on the sensor.

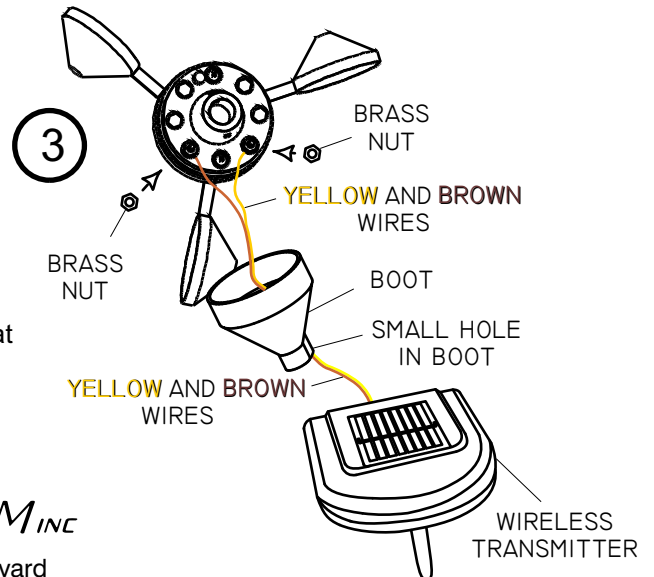

**MAXIMUM** INC

30 Barnet Boulevard  
New Bedford, MA 02745  
(508) 995-2200

# MERLIN

## WIRELESS INSTALLATION

Feed the terminal lug end of the five-conductor cable through the other rubber boot and connect the lugs to the terminals on the bottom of the wind-direction sensor with the brass nuts from the Hardware Pack. Do NOT adjust the nuts that are already on the sensor.

TRANSMITTER WIRING		
WHITE	to	TERMINAL #1
ORANGE	to	TERMINAL #2
BLACK	to	TERMINAL #3
RED	to	TERMINAL #4
GREEN	to	TERMINAL #5

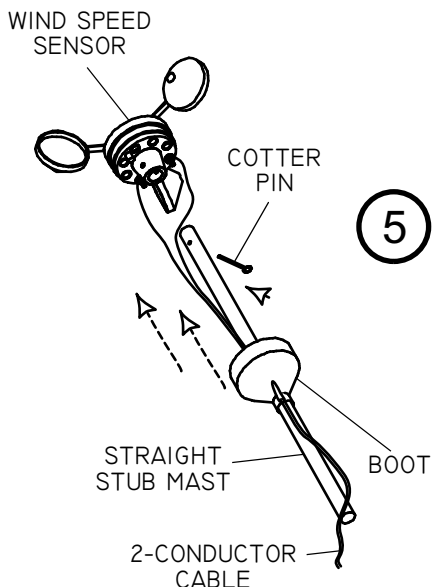
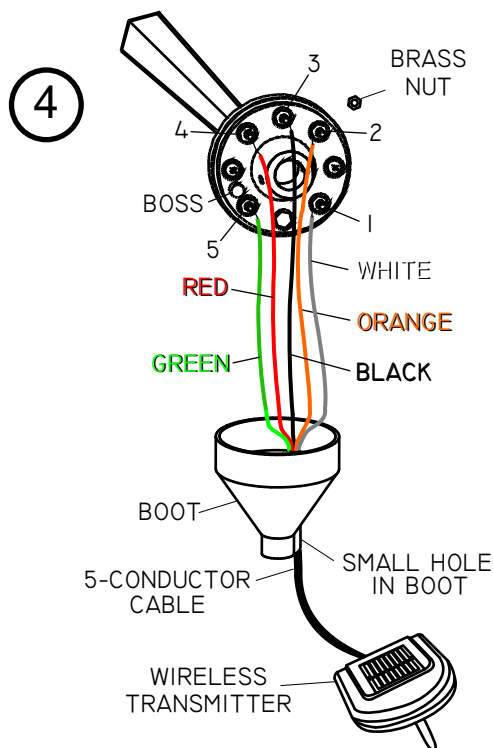

5 Slide the straight stub mast through the black rubber boot and insert it into the Wind Speed Sensor, securing it with the supplied stainless steel cotter pin. Once the final installation is made and proper function is verified, coat all the wire connections with a silicone sealant designed for electrical connections (not supplied). Slip the boot over the base of the sensor.

Slide the "Z" shaped mast through the black rubber boot and insert it into the Wind Direction Sensor. Align the sensor so that the number 3 terminal is located over the horizontal section of the "z" shaped mast and secure it with the supplied stainless steel cotter pin. Once the final installation is made and proper function is verified, coat all the wire connections with a silicone sealant designed for electrical connections (not supplied). Slip the boot over the base of the sensor.

**Align the sensor so that the number 3 terminal is located over the horizontal section of the "z" shaped mast**

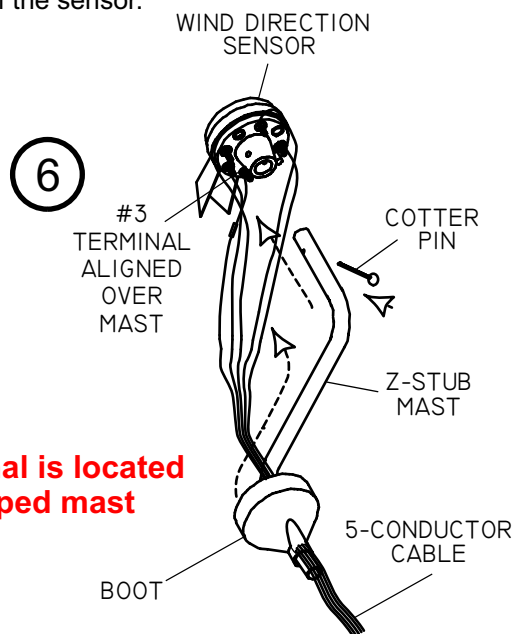

MAXIMUM INC.

30 Barnet Boulevard  
New Bedford, MA 02745  
(508) 995-2200

# MERLIN

## WIRELESS INSTALLATION

7

Open the battery compartment by removing the stainless steel screws in the cover. Insert the two 1000 Milliamp Ni-Cad batteries that have been fully charged per the charger instructions. The test light in the wireless transmitter will blink once to indicate that the batteries have been installed properly.

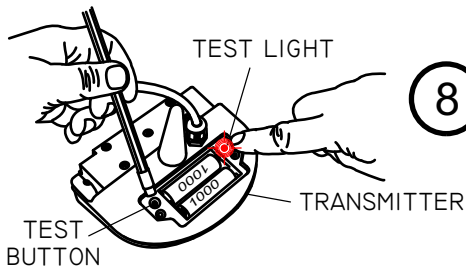
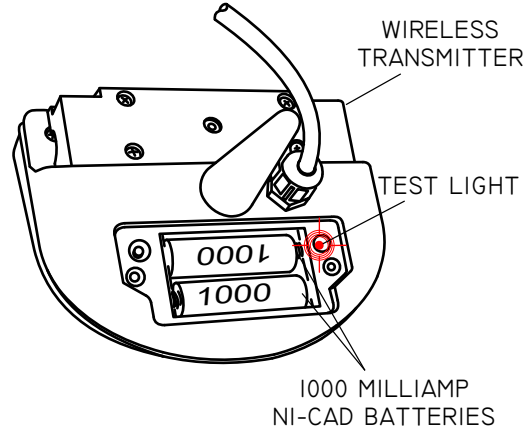

8

Plug in the 12 volt power supply that is connected to the instrument and the receiver. Test the transmitter by depressing the test button. After a few seconds the test light should blink every two seconds. This indicates that the transmitter is in test mode, which lasts for 15 minutes. At the end of 15 minutes the transmitter will return to normal operating mode. After initial power up, the indicator light on the receiver should blink red every two seconds. This indicates proper communication between the receiver and the wind transmitter. (NOTE: If more than 15 minutes has passed since the button on the wind transmitter was pushed it will need to be pushed again.) The light on the receiver will blink other colors when different sensors are installed.

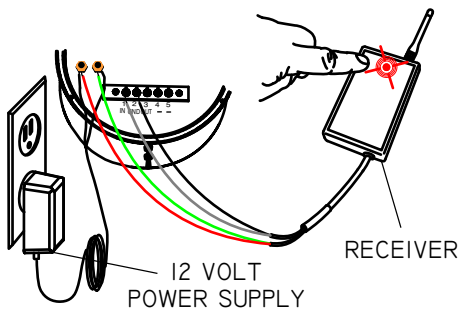

RECEIVER INDICATOR	TRANSMITTER
RED.....	WIND
GREEN.....	TEMPERATURE
ORANGE.....	RAIN

MAXIMUM INC.

30 Barnet Boulevard  
New Bedford, MA 02745  
(508) 995-2200

# MERLIN

## WIRELESS

## INSTALLATION

9

Perform a test of your wireless MERLIN. Spin the cups on the wind sensor and a speed should be indicated on the read out (there will be a brief delay). Slowly rotate the vane on the wind direction sensor and the lights indicating wind direction should change (again, there will be a brief delay).

If the above tests do not produce the results described, refer to the trouble-shooting section at the back of this manual for assistance.

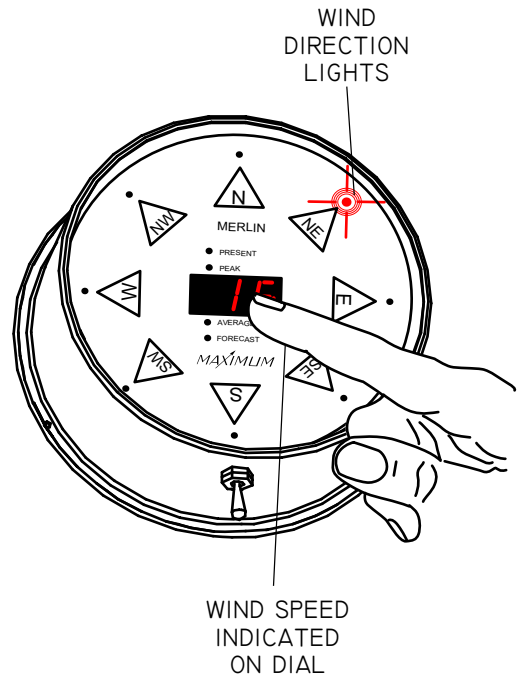

10

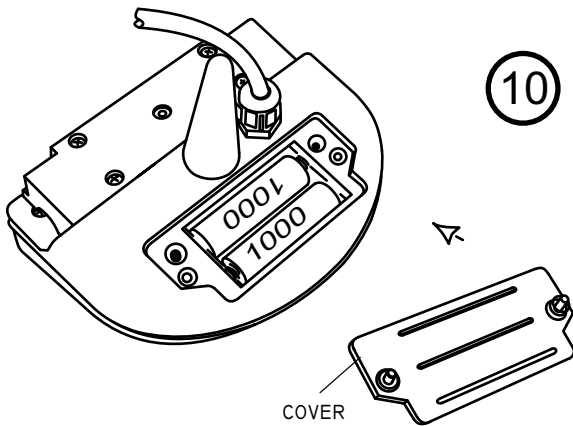

Replace the plastic battery cover. Make sure to seat the cover properly over the glued in gasket.

11

Mount the Wireless Wind Transmitter to the "Z" shaped arm. Remove the four stainless steel screws holding the locking bracket. Place the transmitter over the arm as shown. Insert one stainless steel screw through the center of the locking bracket and into the alignment hole in the z-shaped arm. Re-attach the locking bracket with the four remaining stainless steel screws.

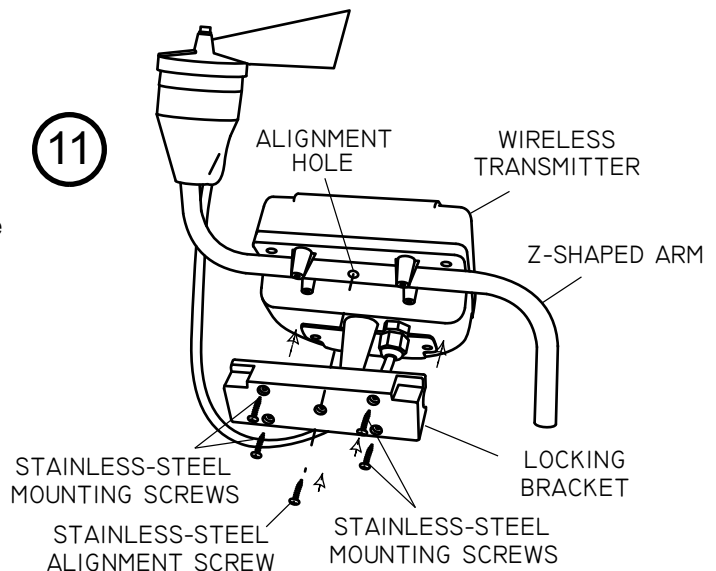

MAXIMUM INC.

30 Barnet Boulevard  
New Bedford, MA 02745  
(508) 995-2200

# MERLIN

## WIRELESS INSTALLATION

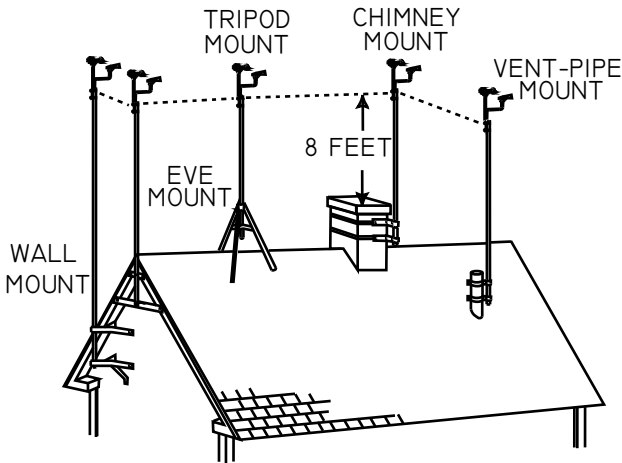

12

A mounting mast and bracket for your particular situation will need to be purchased. Radio Shack and home supply stores often have a selection of masts and mounting brackets. The ideal mounting mast and bracket should provide approximately eight feet of vertical clearance above nearby obstacles. Do not use a mounting mast made of fiberglass or PVC plastic because of electrical grounding considerations. Check with local building/electrical code enforcement officer about mounting mast grounding requirements.

13

Secure the sensors and stub masts to the mounting mast with the two hose clamps provided (see illustration). Move the completed mast assembly as close as possible to your preferred final mounting location. Also move the MERLIN indicator and receiver combination as close as possible to their final mounting location. Check to make sure that proper communication between the receiver and transmitter still exists by verifying that the light on the receiver is still flashing red every two seconds. NOTE: If more than 15 minutes has passed since the button on the wind transmitter was pushed, it will need to be pushed again (see step 8). If the signal has been lost, move to an alternate installation location for a better signal with the receiver flashing every two seconds.

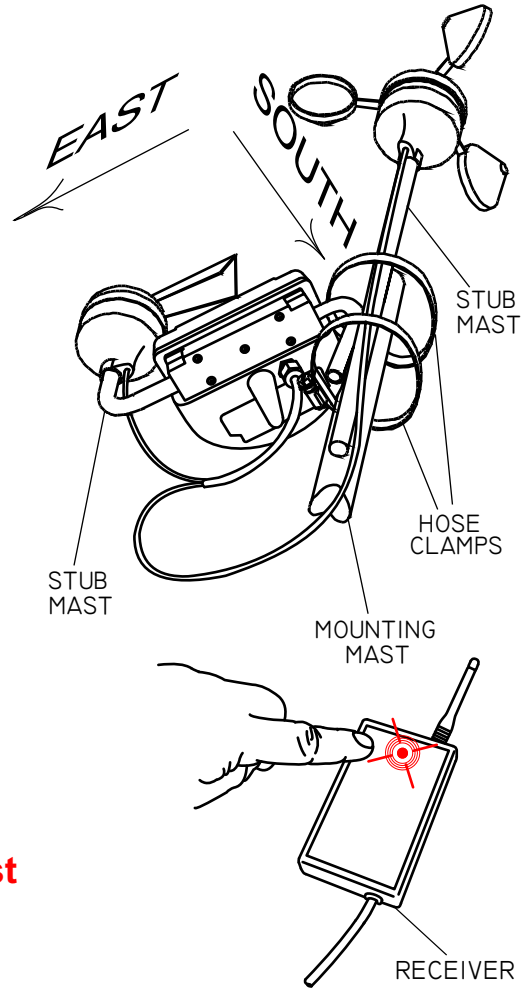

14

Permanently install the mounting mast and brackets following the manufacturer's instructions (See illustration, step 13).

**Make sure that the "Z" shaped arm is facing east and the solar panel is facing south**

MAXIMUM INC.

30 Barnet Boulevard  
New Bedford, MA 02745  
(508) 995-2200

Page 5

# MERLIN

WIRELESS  
INSTALLATION

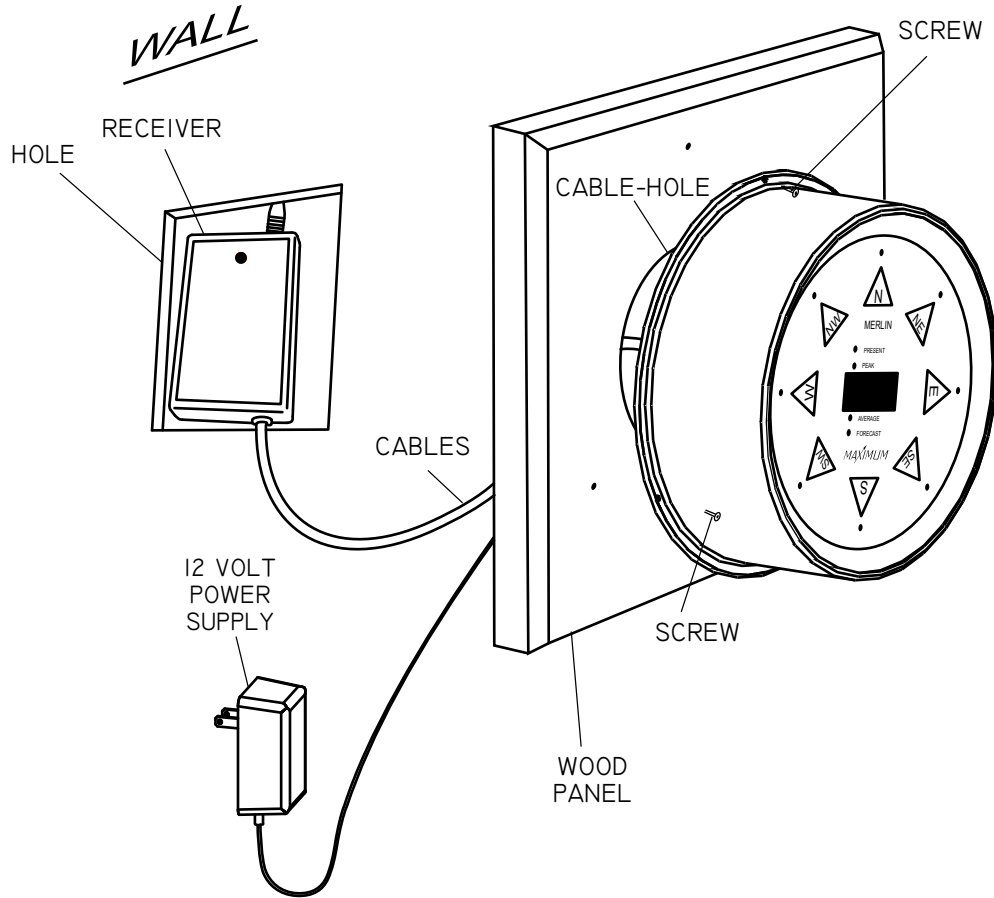

15

Mount the MERLIN indicator directly over the cable hole that is also used to route power to the instrument. For the cleanest installation, we recommend making a hole in the wall large enough to insert the wireless receiver. We also recommend mounting the brass meter to one of our pre-drilled mounting panels.

*MAXIMUM* INC.

30 Barnet Boulevard  
New Bedford, MA 02745  
(508) 995-2200

# MERLIN

WIRELESS

## OPTIONAL INSTALLATION

### MERLIN WITH MYSTIC

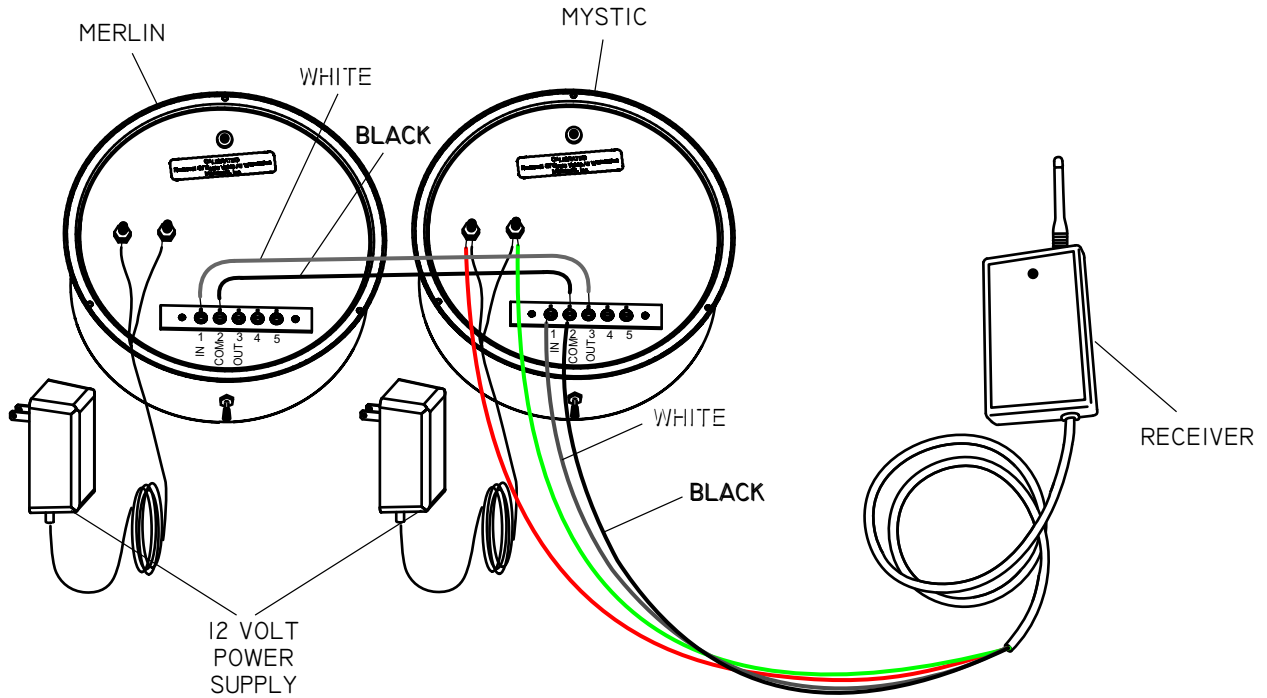

#### MERLIN AND MYSTIC CONNECTIONS

- ① Connect the **RED** and **GREEN** wires from the RECEIVER to the power terminals on the back of the MYSTIC (no polarity).  
Connect the wires from the 12 VOLT POWER SUPPLY to the same MYSTIC power terminals (no polarity).
- ② On the MYSTIC, connect the **WHITE** wire from the RECEIVER to TERMINAL #1 (IN) and the **BLACK** wire from the RECEIVER to TERMINAL #2 (COM).
- ③ Connect the two instruments using the supplied grey sheathed **BLACK** and **WHITE** wires as follows:
  - A. Connect the **WHITE** wire from MERLIN TERMINAL #1 (IN) to MYSTIC TERMINAL #3 (OUT)
  - B. Connect the **BLACK** wire from MERLIN TERMINAL #2 (COM) to MYSTIC TERMINAL #2 (COM)
- ④ Connect the wires from the 12 VOLT POWER SUPPLY to the MERLIN power terminals (no polarity).

*MAXIMUM* INC.

30 Barnet Boulevard  
New Bedford, MA 02745  
(508) 995-2200  
Page 7

# MERLIN

## WIRELESS

### OPTIONAL INSTALLATION MERLIN WITH MYSTIC AND RAINWATCH

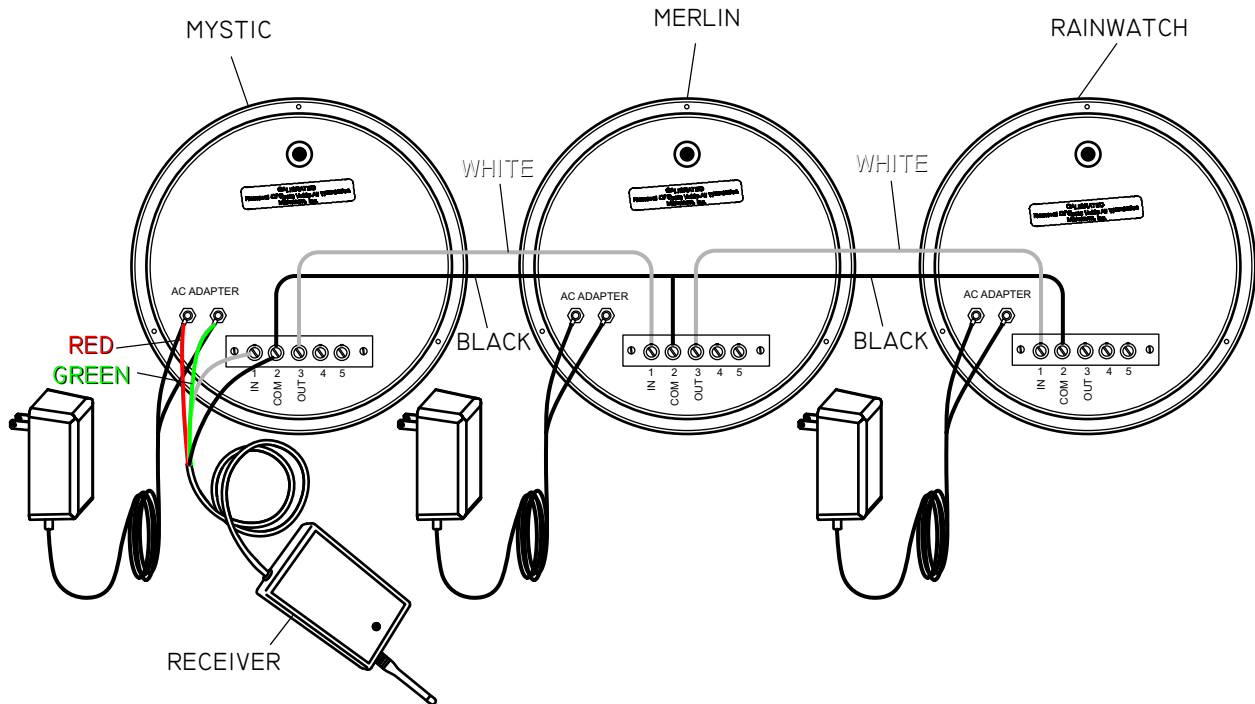

#### RAINWATCH WITH MERLIN AND MYSTIC CONNECTIONS

- ① Connect the **RED** and **GREEN** wires from the RECEIVER to the power terminals on the back of the MYSTIC (no polarity).  
Connect the wires from the 12 VOLT POWER SUPPLY to the same MYSTIC power terminals (no polarity).
- ② On the MYSTIC, connect the **WHITE** wire from the RECEIVER to TERMINAL #1 (IN) and the **BLACK** wire from the RECEIVER to TERMINAL #2 (COM).
- ③ Connect the MYSTIC and MERLIN instruments using the supplied grey sheathed **BLACK** and **WHITE** wires as follows:  
A. Connect the **WHITE** wire from MERLIN TERMINAL #1 (IN) to MYSTIC TERMINAL #3 (OUT).  
B. Connect the **BLACK** wire from MERLIN TERMINAL #2 (COM) to MYSTIC TERMINAL #2 (COM).
- ④ Connect the MERLIN and RAINWATCH instruments using the supplied grey sheathed **BLACK** and **WHITE** wires as follows:  
A. Connect the **WHITE** wire from RAINWATCH TERMINAL #1(IN) to MERLIN TERMINAL #3 (OUT)  
B. Connect the **BLACK** wire from RAINWATCH TERMINAL #2(COM) to MERLIN TERMINAL #2(COM).

*MAXIMUM* INC.

30 Barnet Boulevard  
New Bedford, MA 02745  
(508) 995-2200



# MERLIN

## WIRELESS OPERATION

With the switch in the center (resting) position, MERLIN will display the information indicated by the illuminated function (Present, Peak, Average, or Forecast).

To select a function, move the switch to the right and allow it to return to the center. This toggles Merlin to the next function. Repeat this until you see the function that you wish.

To auto-sequence through all of the functions, hold the switch to the right for at least three seconds. You will see each function light stay on and the corresponding information displayed for approximately four seconds. MERLIN will then move to the next function automatically.

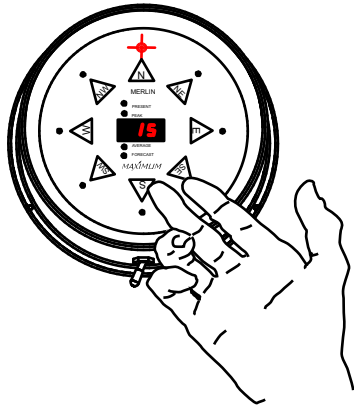
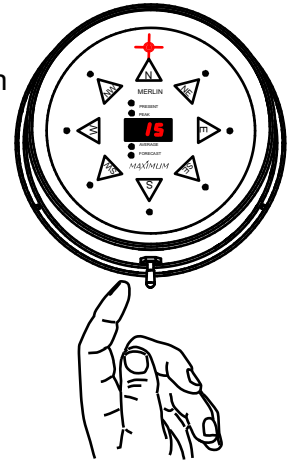

To return to the manual sequencing mode, move the switch briefly to the right and then let it return to center.

To reset all the stored functions at once, select the "Present" function by moving the switch to the right and releasing until the "Present" light is illuminated. Then hold the switch to the left until the display blanks out (about six seconds). The unit will then perform a self-test and return to normal operation.

Resetting the Peak, Average and Forecast functions individually can be done by toggling to the function that you wish to reset. Then hold the switch to the left for at least 6 seconds. At that point you will see the display reset itself.

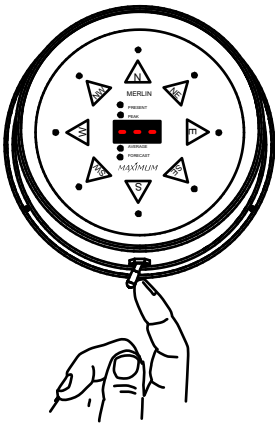
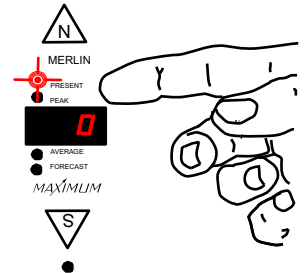

## SETTING UNITS OF MEASUREMENT

Merlin can be set to display the wind speed in miles per hour, knots, kilometers per hour or meters per second. To change the units of measurement follow these steps:

1. Press the small push button switch on the back of the MERLIN indicator. The display will show "UN" and a number. The number indicates the units of measurement.

UN0 = miles per hour

UN1 = meters per second

UN2 = kilometers per hour

UN3 = knots

2. Press the push button again to advance through the available units.

3. When you have the code showing for the units of measurement you want, press the toggle switch on the side of the case to the right (auto position).

Merlin will then perform a self-test and return to normal operation.

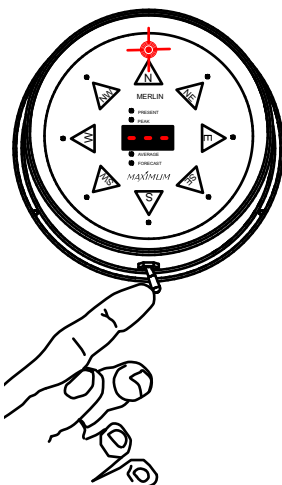
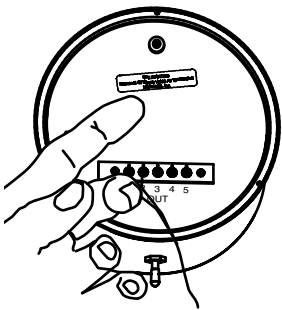

*MAXIMUM* INC.

30 Barnet Boulevard  
New Bedford, MA 02745  
(508) 995-2200

# MERLIN

## WIRELESS OPERATION

(CONTINUED)

**Peak Wind-** When first powering up MERLIN, after long power outages, or when totally resetting, the Peak Wind direction LEDs will not function until wind has been recorded.

**Average Wind-** The first reading after setting the Average will be the current wind speed. This reading will settle out as MERLIN accumulates more data. Prevailing wind direction lights will not function until 12 minutes after powering up or resetting. As with the wind speed there will be no prevailing direction indication if there is no wind.

**Forecast-** When first powering up MERLIN, after long power outages, or when totally resetting, the Forecast display will read "hld" (hold) for 24 minutes while MERLIN is loading its memory. During the 25th minute MERLIN will make a trend reading "inc" (increase), "dec" (decrease), "---" (no change) in wind speed based on comparing two 12-minute blocks of time. If there has been no wind for an entire 12 minute timing interval, the direction lights will blank out. If there is no wind for the next 12 minutes then the display will show "---" and the direction lights will remain off.

**Wind Direction-** MERLIN takes a reading every second. When the wind changes direction very rapidly (faster than 1 second), some direction lights may not light. This is normal operation as MERLIN is simply between readings.

**Latch Up-** Power Line disturbances or improper installation (plugging in the AC Adapter before attaching to instrument) can cause a blank or improper display reading. If MERLIN is "latched up" proceed as follows:

1. Unplug the AC adapter.
2. Wait 15 seconds.
3. Plug the AC adapter back in to a 110 VAC outlet.

- During power outages MERLIN's display will blank out and the instrument will not continue to accumulate data. It will preserve the previously accumulated data for up to 10 years.
- Using the Forecast function and periodically updated Average function together, you can often watch not only small changes in wind conditions but more significant "backing" and "veering" patterns foretelling frontal movements.
- If you are unsure as to when Forecast made it's last update, wait more than 12 minutes and read again (it updates every 12 minutes).
- When MERLIN is in the *Peak, Average, and Forecast* modes the direction lights blink. This indicates that you are observing recorded data and not the present wind direction.
- Setting the switch to Auto does not erase stored data.
- You do not need to time the 6 second reset time, MERLIN will blank out the display to indicate that the memory has been erased.

*MAXIMUM* INC.

30 Barnet Boulevard  
New Bedford, MA 02745  
(508) 995-2200

# WIRELESS

## TROUBLE-SHOOTING

Occasionally, you may experience disruptions in data transmission. The most likely cause will be expired batteries in the Exterior Sensor/Transmitters. When the following error codes appear in the LED readout, the batteries will most likely need replacing (please note the location of the horizontal dash lines):



Wind sensor not transmitting



Temperature sensor not transmitting



Rain sensor not transmitting



Wind and Temperature sensor not transmitting



Wind and Rain sensor not transmitting



Temperature and rain sensor not transmitting



Wind, Temperature and Rain sensor not transmitting

**NS=No Signal**

The following pages of this manual contain more detailed information regarding the specific error displays.

*MAXIMUM* INC.

30 Barnet Boulevard  
New Bedford, MA 02745  
(508) 995-2200

# WIRELESS

## TROUBLE-SHOOTING

THE FOLLOWING ILLUSTRATIONS SHOW HOW THE INSTRUMENT DIAL WILL INDICATE IMPROPER OPERATION.

### NO SERIAL DATA

(Instrument has never recognized a receiver)

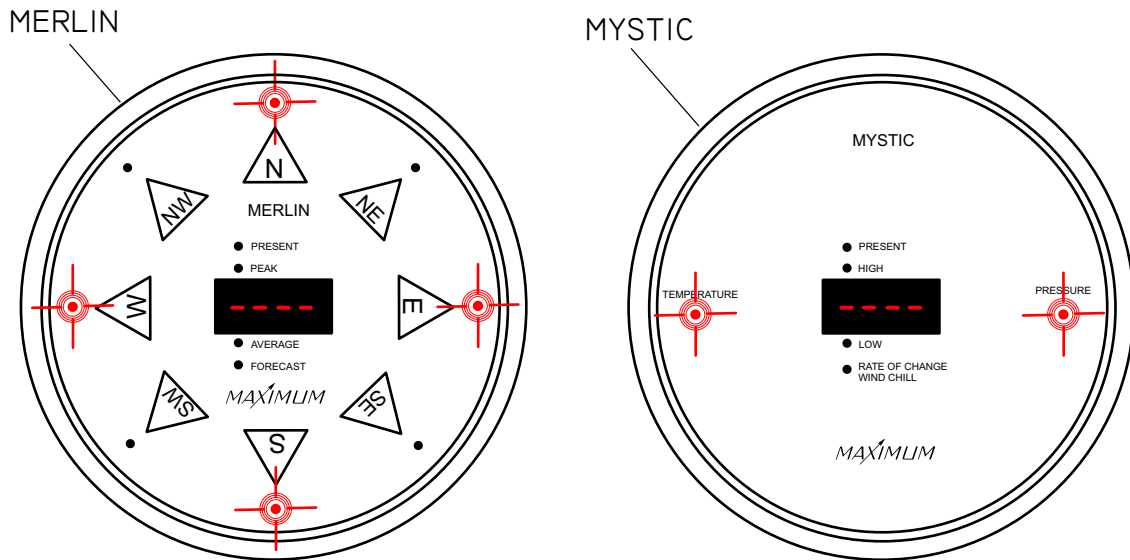

#### SYMPTOM:

- Center (Numeric) LED's display "----".
- Merlin Primary Wind Direction LED's are illuminated.
- Mystic Temperature and Pressure LED's are illuminated.

#### REMEDY:

- Check all wire connections (Refer to installation diagrams)
- Re-boot the system by unplugging the power supply, wait 30 seconds, plug it back in.
- The light on the receiver will flash **RED** and then **GREEN** five times, indicating that the receiver is now powered-up.
- If the instrument continues to display the error code, call Maximum for further assistance.

Note: Depending on the origin of the problem, error codes may not display on all instruments.

*MAXIMUM INC.*

30 Barnet Boulevard  
New Bedford, MA 02745  
(508) 995-2200

# WIRELESS

## TROUBLE-SHOOTING

### NO SIGNAL FROM ANY TRANSMITTER

(Instrument recognizes the receiver, but the receiver does not recognize the sensor(s))

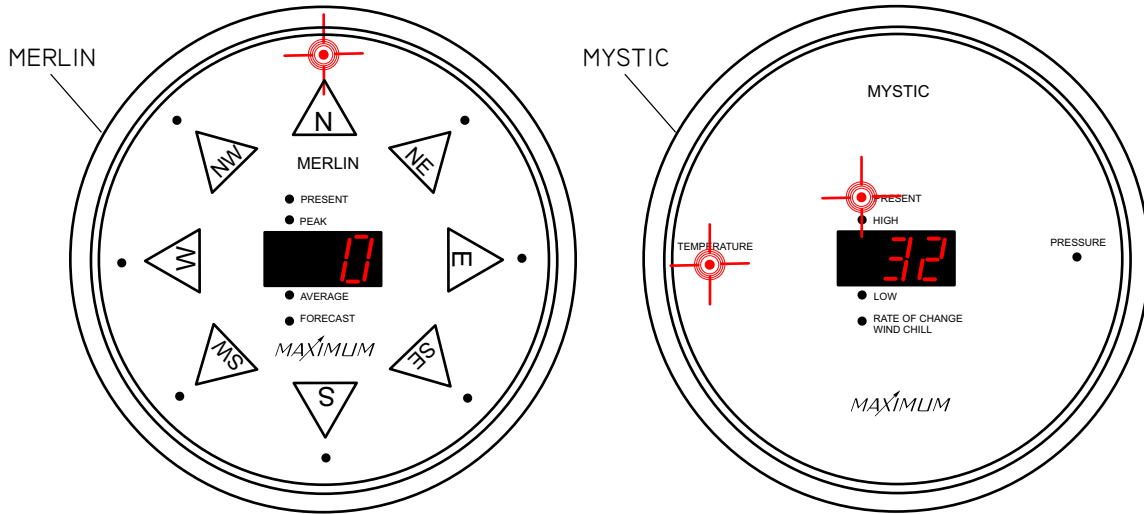

#### SYMPTOM:

- Merlin reads 0 mph and the North direction LED is illuminated.
- Mystic reads 32°F and the Temperature and Present LED's are illuminated.

#### REMEDY:

- Test the batteries in each external SENSOR/TRANSMITTER and replace if necessary.
- Put the TRANSMITTER(S) into TEST MODE by pressing TEST BUTTON in the battery compartment of TRANSMITTER.
- Remove the RECEIVER from the wall and confirm receipt of TRANSMISSION(S) based on the color of the flashing light.

RECEIVER INDICATOR	TRANSMITTER
RED.....	WIND
GREEN.....	TEMPERATURE
ORANGE.....	RAIN

-If the instrument continues to display the error code, call Maximum for further assistance.

Note: Depending on the origin of the problem, error codes may not display on all instruments.

*MAXIMUM* INC.

30 Barnet Boulevard  
New Bedford, MA 02745  
(508) 995-2200

# WIRELESS

## TROUBLE-SHOOTING

### NO SIGNAL FROM WIND TRANSMITTER (Instrument has received, then lost sensor signal)

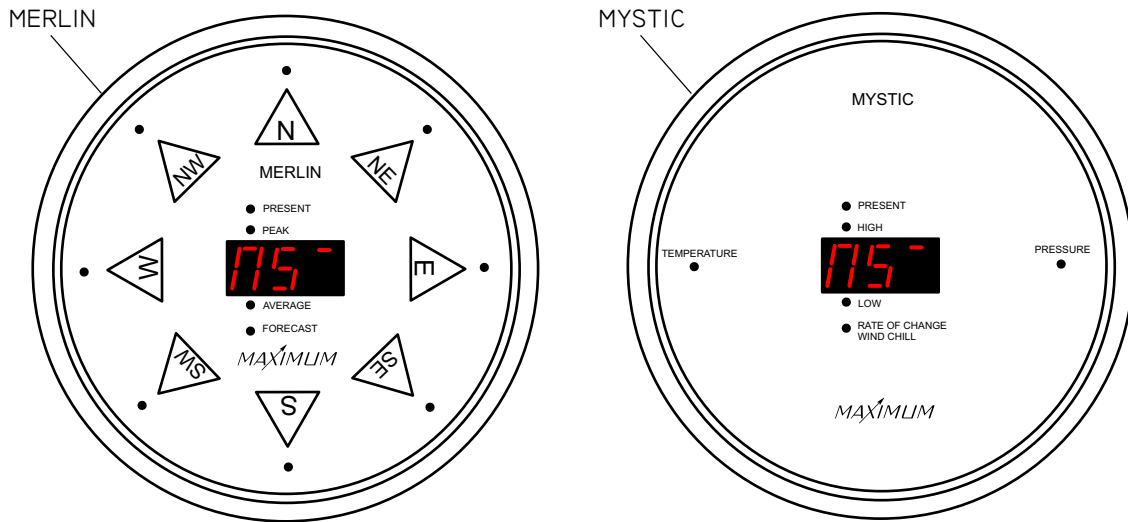

#### SYMPTOM:

- Merlin Reads "NS" (No Direction LED's illuminated).
- Mystic Reads "NS" (No Temperature or Pressure LED's illuminated).

#### REMEDY:

- Re-charge and/or replace the **AA NiCad** batteries in the WIND TRANSMITTER.
- Put TRANSMITTER into TEST MODE by pressing the TEST BUTTON in the battery compartment of TRANSMITTER. This should cause the LED on the receiver to flash **RED** every 2 seconds.
- If the instrument continues to display the error code, call Maximum for further assistance.

*MAXIMUM* INC.

30 Barnet Boulevard  
New Bedford, MA 02745  
(508) 995-2200

# WIRELESS

## TROUBLE-SHOOTING

### NO SIGNAL FROM TEMPERATURE TRANSMITTER (Instrument has received, then lost sensor signal)

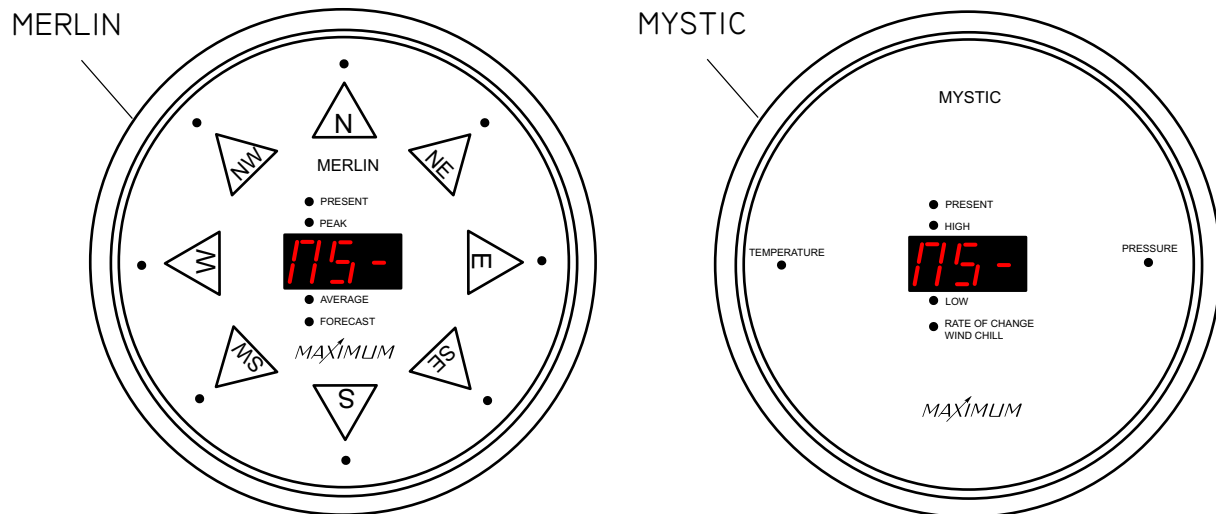

#### SYMPTOM:

- Merlin Reads "NS-" (No Direction LED's illuminated).
- Mystic Reads "NS-" (No Temperature or Pressure LED's illuminated).

#### REMEDY:

- Test and replace (if necessary) the AA Alkaline batteries in the TEMPERATURE TRANSMITTER.
- Put TRANSMITTER into TEST MODE by pressing the TEST BUTTON in the battery compartment of the TRANSMITTER. This should cause the LED on the receiver to flash GREEN every 4 seconds.
- If the instrument continues to display the error code, call Maximum for further assistance.

*MAXIMUM* INC.

30 Barnet Boulevard  
New Bedford, MA 02745  
(508) 995-2200

# WIRELESS

## TROUBLE-SHOOTING

### NO SIGNAL FROM RAIN TRANSMITTER (Instrument has received, then lost sensor signal)

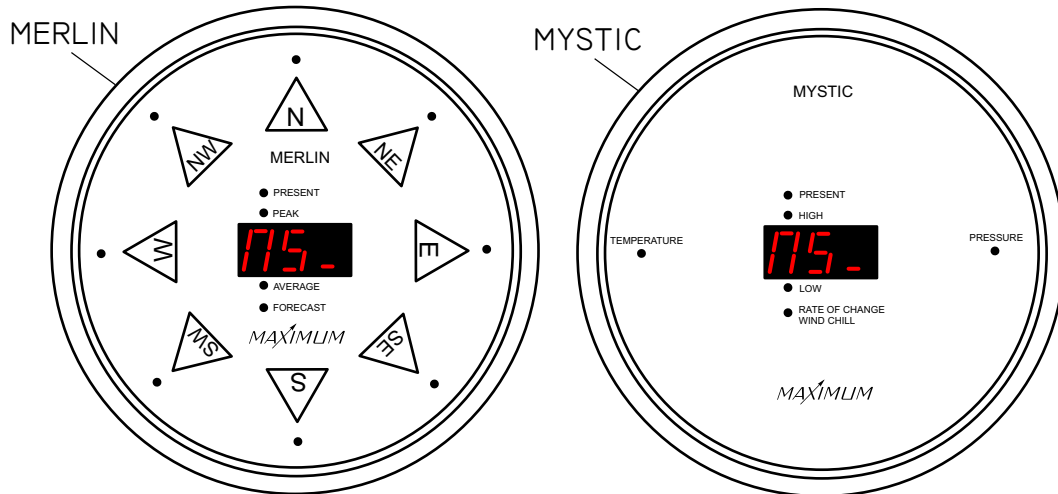

#### SYMPTOM:

- Merlin Reads "NS-" (No Direction LED's illuminated).
- Mystic Reads "NS-" (No Temperature or Pressure LED's illuminated).

#### REMEDY:

- Test and replace (if necessary) the AA Alkaline batteries in the RAIN TRANSMITTER.
- Put the RAIN TRANSMITTER into TEST MODE by removing the batteries, then moving the jumper on the RAIN TRANSMITTER circuit board to cover both pins of the 2-pin terminal.

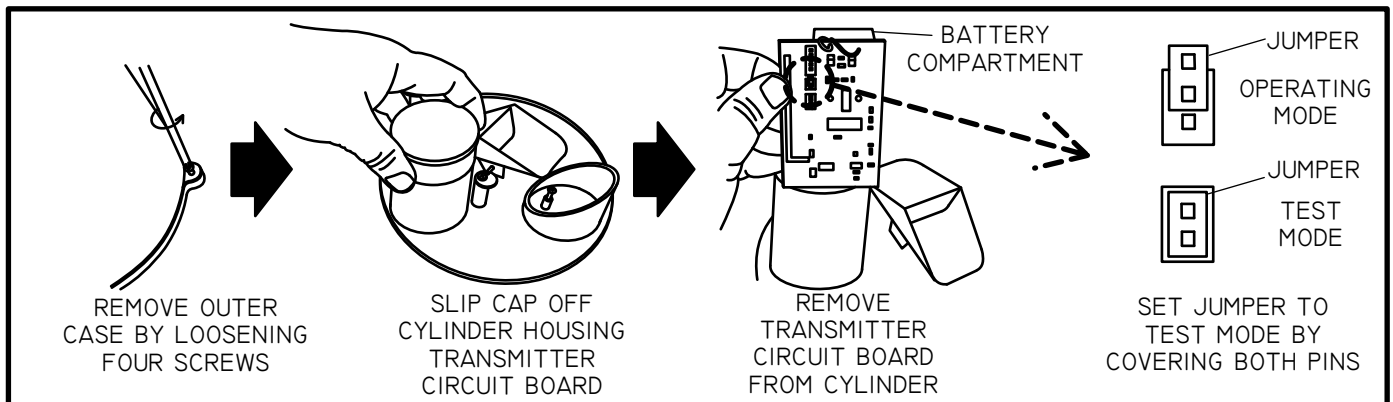

- Re-install the AA Alkaline batteries in the RAIN TRANSMITTER once the jumper has been moved.
- Check LED on receiver to make sure it is blinking **ORANGE** every 4 seconds.
- Check the instruments to see if the error has been corrected.
- Unlike the WIND and TEMPERATURE TRANSMITTERS, the RAIN TRANSMITTER will not automatically exit test MODE after 15 minutes. Therefore, you must take the rain transmitter out of test mode manually. To do so: remove the batteries, then move the jumper on the RAIN TRANSMITTER circuit board back to covering only one pin of the 2-pin terminal (it does not matter which pin is covered). Re-install the batteries and cover.
- If the instrument continues to display the error code, call Maximum for further assistance.

**MAXIMUM** INC.

30 Barnet Boulevard  
New Bedford, MA 02745  
(508) 995-2200







## **Electrical Damage - Common Causes & Recommended Prevention**

Electrical damage can be caused by many different factors. Below are some of the more common causes and some suggested methods of minimizing potential problems.

### **Common Causes:**

**Storm Activity** - lightening in your area can do damage to your instruments in different ways. The obvious way is due to a direct or nearby strike. In addition, lightening storms, dust storms, dry snowstorms and strong dry winds can all cause static electricity to build up on and around your external sensors. Regardless of the cause, this built up electricity itself through the cable connecting the external sensors to the instrument.

**Power Surges** - A surge may come from the electric company's switching generators or power grids, from local industries or after power interruption when accumulated power suddenly surges back through AC lines. Even the on-and-off switching of large electrical appliances, such as refrigerators or clothes dryers can create damaging fluctuations. This is especially true with sensitive weather recording devices.

**Yourself** - Are you constantly giving and/or receiving a shock every time you touch a doorknob or other person? If so, you have a great deal of static electricity in your environment. In either case, it is possible for a person to carry enough of a charge to damage an instrument.

### **Recommended Prevention:**

**Ground Your Mounting Mast – IMPORTANT:** PVC and fiberglass are not recommended mast materials as they can store high amounts of static electricity within themselves. It is recommended that you follow the grounding instructions that came with your mounting mast, while also maintaining accordance to your local Electric Code. In the absence of instructions for your mast system, the following generic guidelines from the National Electric Code may be helpful.

- 1) The NEC requires that the antenna mast and mount be grounded directly. No splices or connections are allowed in the ground wire between the mast and the ground rod.
- 2) Attach one end of a No. 8 (or thicker) copper or aluminum ground wire to the antenna mast. Note: As static electricity issues are more common for weather sensors than direct lightening strikes, consider installing the ground wire as physically close to the wind sensors as possible to best combat static electricity issues. For multi-piece (or telescoping) masts, consider connecting the ground to each separate section of the mast.
- 3) For painted or coated masts, scrape off the coating around the area where the contact will be made. This will ensure a good, solid connection. (Once the ground is attached to the mast, any scraped off portion that is exposed should be recoated with paint or other sealant.)
- 4) Next, run the ground wire to ground as directly as possible. Standard wire staples can be used to secure the ground wire against the side of the house. Avoid making 90° or sharper turns with the ground wire. A lightning charge has difficulty making such a turn and therefore may discharge into the house. Make ground wire bends as smooth and as gradual as possible.
- 5) The ground wire must be connected to a ground rod. Water pipes or plumbing fixtures are not acceptable. A good copper-coated steel ground rod driven at least 3 feet into the ground is required. Special clamps that provide a solid connection between the ground wire and ground rod should be used

**Use Surge Protectors** - for the AC adapter, a UL 1449 rated surge protector with EMI/RFI filtering is recommended. This rating will be clearly listed on the packaging of all good quality surge protector.

**Discharge Yourself** - If the instruments are located in an environment where static electricity is a problem, make sure that you discharge yourself before touching the instrument(s). The shock that you get from touching a doorknob or another person can often be sufficient to damage an instrument.

**30 SAMUEL BARNET BOULEVARD ✦ NEW BEDFORD, MASSACHUSETTS 02745 U.S.A.  
TEL. 508.995.2200 ✦ WWW.MAXIMUM-INC.COM ✦ FAX 800.989.2580**