

MERLIN INSTALLATION

PROPER INSTALLATION IS IMPORTANT. IF YOU NEED ASSISTANCE, CONSULT A CONTRACTOR, ELECTRICIAN OR TELEVISION ANTENNA INSTALLER (CHECK WITH YOUR LOCAL BUILDING SUPPLY, OR HARDWARE STORE FOR REFERRALS). TO PROMOTE CONFIDENCE, PERFORM A TRIAL WIRING BEFORE INSTALLATION.

- 1 Determine where you are going to locate both the rooftop sensors and the read-out.

Feed the terminal lug end of the black and white wires through one of the rubber boots and connect the lugs to the terminals on the bottom of the wind speed sensor using the brass nuts provided. The polarity does not matter. (Do NOT adjust the nuts that are already on the sensor).

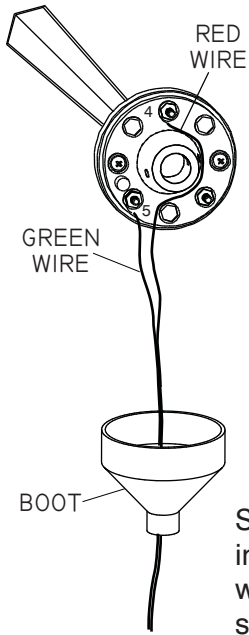
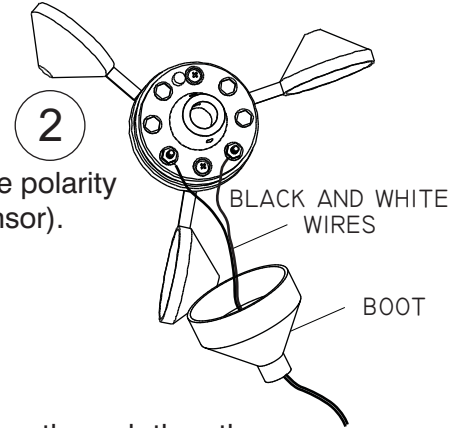

- 3 Feed the terminal lug end of the red and green wires through the other rubber boot. Connect the red wire to the terminal marked #4. Connect the green wire to the terminal marked #5. The polarity MUST be observed. Use the hex nuts provided. (Do NOT adjust the nuts that are already on the wind direction sensor).

Slide the stub masts through the rubber boots and insert the stub masts into the bottom of the sensors. Secure with the cotter pins. Coat all wire connections with silicone sealant and slip the boots over the sensors.

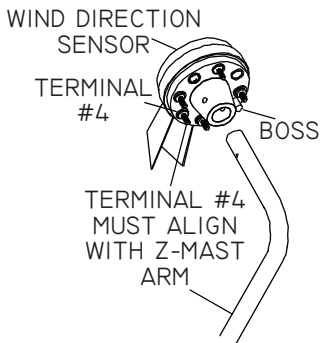
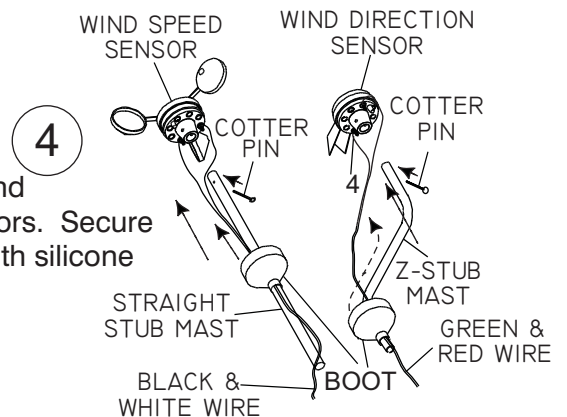

- 4A When connecting the wind direction sensor to the Z-mast, make certain that terminal #4 is aligned with the Z-mast arm. If the sensor is not installed in this manner your wind direction readings will be incorrect.

Secure the sensors and stub masts to your antenna mast (not supplied) with the two hose clamps. **Align the wind-direction Z-mast arm to true North.** Radio Shack and similar stores have a selection of tall masts and roof mounting brackets. Choose a mount that best suits your location and provides at least eight feet of vertical clearance above objects on the roof.

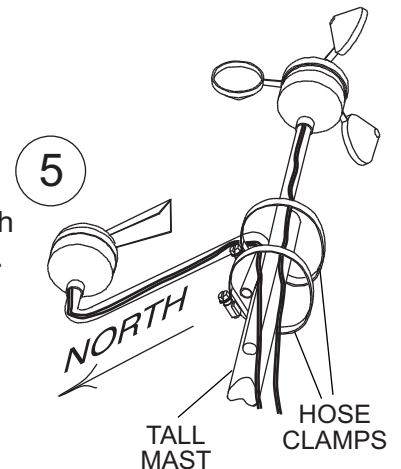

MAXIMUM INC

30 Barnet Boulevard
New Bedford, MA 02745
(508) 995-2200

MERLIN

INSTALLATION

(continued)

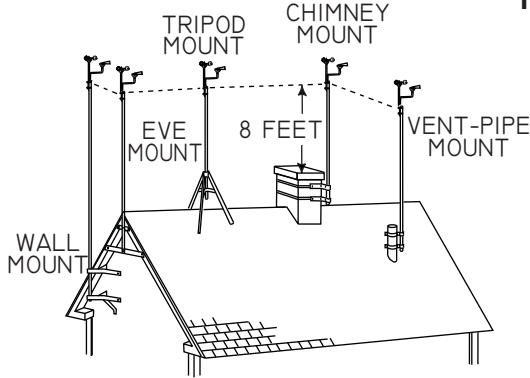

6

Follow the instructions supplied with the antenna mount and secure the mast to the mount.

7

Secure the wire to the building using cable clips (do not use regular staples). Form a drip loop where the wires enter the hole drilled through the exterior wall. Caulk the hole when done.

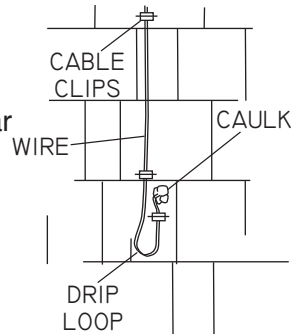

8

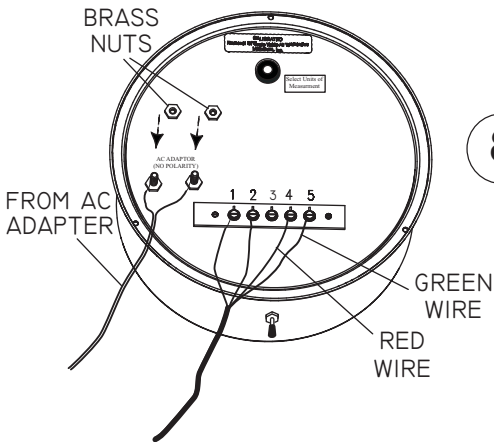

Feed the cables through the wall to where the read-out is going to be located. Attach the wires to the rear of the read-out as shown. The red wire from the direction sensor cable connects to terminal #4. The green wire to terminal #5. Connect the black and white wires from the speed sensor to terminals #1 and #2. The polarity does not matter. Although the cable shield itself is not connected, shielded cable must be used. Connect the wires from the AC adapter to the meter. The polarity does not matter. (Do NOT adjust the nuts that are already on the meter).

9

Mount the brass read-out directly over the cable feed-thru-hole to avoid crimping the wire under the lip. We recommend mounting the read-out on one of our pre-drilled and centered panels. Plug the power supply into a 110 VAC power outlet.

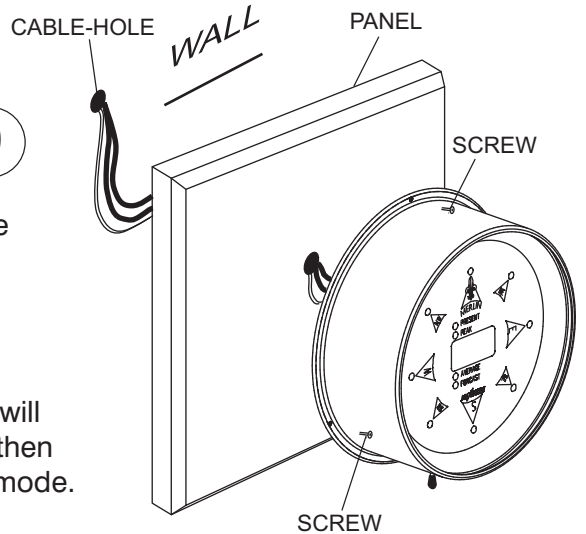

10

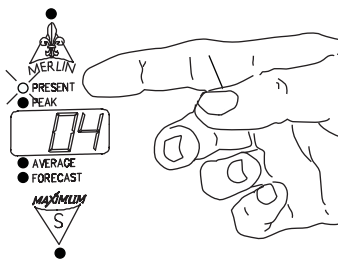

When Merlin first starts up it will perform a brief self-test and then go to the "Present" function mode.

11

Reset all memory functions (see operating instructions). Resetting gives Merlin a fresh starting point for your reference.

MAXIMUM INC

30 Barnet Boulevard
New Bedford, MA 02745
(508) 995-2200

MERLIN

OPERATION

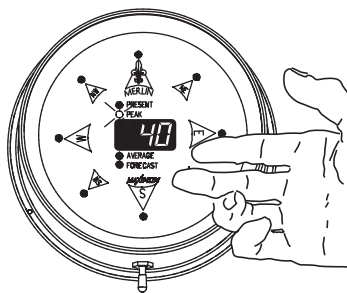

With the switch in the center (resting) position, MERLIN will display the information indicated by the illuminated function (Present, Peak, Average, or Forecast).

To select a function, move the switch to the right and allow it to return to the center. This toggles Merlin to the next function. Repeat this until you see the function that you wish.

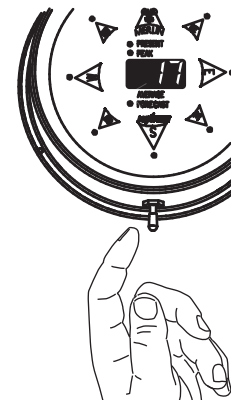

To auto-sequence through all of the functions, hold the switch to the right for at least three seconds. You will see each function light stay on and the corresponding information displayed for approximately four seconds. MERLIN will then move to the next function automatically.

To return to the manual sequencing mode, move the switch briefly to the right and then let it return to center.

To reset all the stored functions at once, select the "Present" function by moving the switch to the right and releasing until the "Present" light is illuminated. Then hold the switch to the left until the display blanks out (about six seconds). The unit will then perform a self-test and return to normal operation.

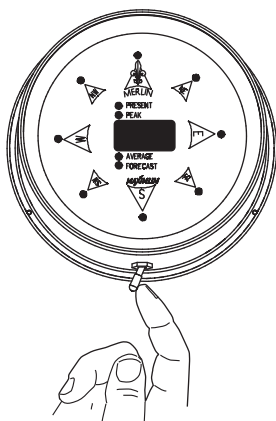

Resetting the Peak, Average and Forecast functions individually can be done by toggling to the function that you wish to reset. Then hold the switch to the left for at least 6 seconds. At that point you will see the display reset itself.

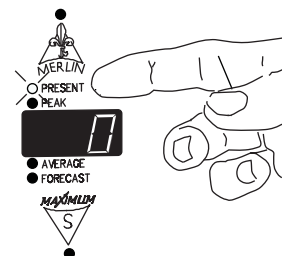

SETTING UNITS OF MEASUREMENT

Merlin can be set to display the wind speed in miles per hour, knots, kilometers per hour or meters per second. To change the units of measurement follow these steps:

1. Press the small push button switch on the back of the indicator. The display will show "UN" and a number. The number indicates the units of measurement.

UN0 = miles per hour

UN1 = meters per second

UN2 = kilometers per hour

UN3 = knots

2. Press the push button again to advance through the available units.

3. When you have the code showing for the units of measurement you want, press the toggle switch on the side of the case to the right (auto position).

Merlin will then perform a self-test and return to normal operation.

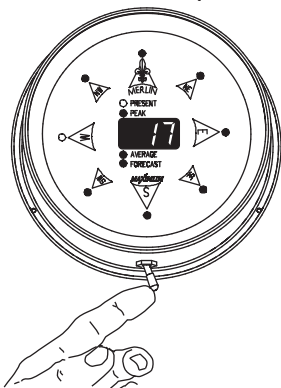
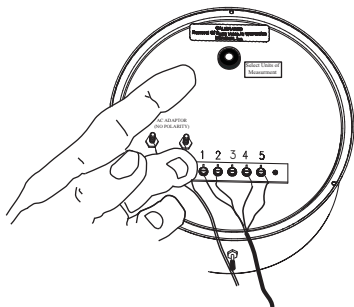

MAXIMUM INC

30 Barnet Boulevard
New Bedford, MA 02745

(508) 995-2200

Page 3

MERLIN

OPERATION

(CONTINUED)

Peak Wind- When first powering up MERLIN, after long power outages, or when totally resetting, the Peak Wind direction LEDs will not function until at least 1 MPH wind has been recorded.

Average Wind- The first reading after setting the Average will be the current wind speed. This reading will settle out as MERLIN accumulates more data. Prevailing wind direction lights will not function until 12 minutes after powering up or resetting. As with the wind speed there will be no prevailing direction indication if there is not wind.

Forecast- When first powering up MERLIN, after long power outages, or when totally resetting, the Forecast display will read "hld" (hold) for 24 minutes while MERLIN is loading its memory. During the 25th minute MERLIN will make a trend reading "inc" (increase), "dec" (decrease), "---" (no change) in wind speed based on comparing two 12-minute blocks of time. If there has been no wind for an entire 12 minute timing interval, the direction lights will blank out. If there is no wind for the next 12 minutes then the display will show "---" and the direction lights will remain off.

Wind Direction- MERLIN takes a reading every second. When the wind changes direction very rapidly (faster than 1 second), some direction lights may not light. This is normal operation as MERLIN is simply between readings.

Latch Up- Power Line disturbances or improper powering up (plugging in the AC Adapter before wiring) can cause a blank or improper display reading. If MERLIN is "latched up" proceed as follows:

1. Unplug the AC adapter.
2. Wait 15 seconds.
3. Plug the AC adapter back in to a 110 VAC outlet.

- During long power outages MERLIN's display will blank out and the instrument will not continue to accumulate data. It will preserve the previously accumulated data for up to 10 years.
- Using the Forecast function and periodically updated Average function together, you can often watch not only small changes in wind conditions but more significant "backing" and "veering" patterns fortelling frontal movements.
- If you are unsure as to when Forecast made it's last update, wait more than 12 minutes and read again (it updates every 12 minutes).
- When MERLIN is in the *Peak, Average, and Forecast* modes the direction lights blink. This indicates that you are observing recorded data and not the present wind direction.
- Setting the switch to Auto does not erase stored data.
- You do not need to time the 6 second reset time, MERLIN will blank out the display to indicate that the memory has been erased.

MAXIMUM INC

30 Barnet Boulevard
New Bedford, MA 02745
(508) 995-2200
Page 4

MERLIN

TROUBLE SHOOTING (WIND DIRECTION)

Perform the latch up corrections as previously detailed.

The unit will now perform the self test, all LEDs will light for about 3 seconds. If you do not have time to check that all LEDs light, repeat the procedure. This will cause the self test to start again. If some or all of the LEDs do not light, then the fault is in the instrument.

IF ALL LEDS LIGHT.....

- 1 Disconnect the sensor wires from the back of the meter.
- 2 Connect a jumper wire (a paper clip will suffice) between terminals #4 and #5. The instrument should indicate "0" wind speed and "WSW" direction. If it does then continue to step 4. If not, continue to step 3.

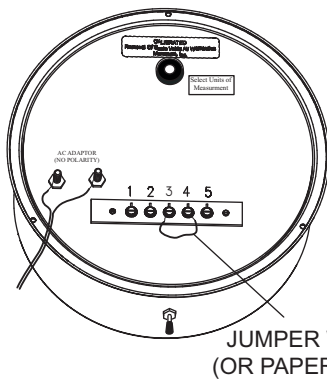
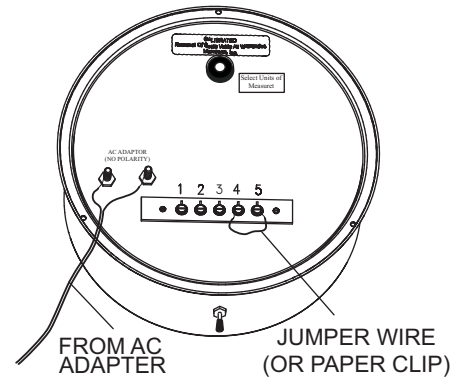

- 3 Connect the same jumper wire used in step 2 to between terminals #3 and #4. The instrument should now indicate "0" wind speed and "WSW" direction. If it does then continue to step 4. If not, the fault is in the instrument.

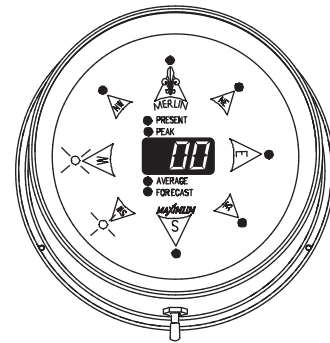

IF THE INSTRUMENT TESTS OKAY.....

- 4 Reconnect the wind direction wires. If there is still a fault in the wind direction portion, then the problem is in the wind direction sensor or the installed wire.

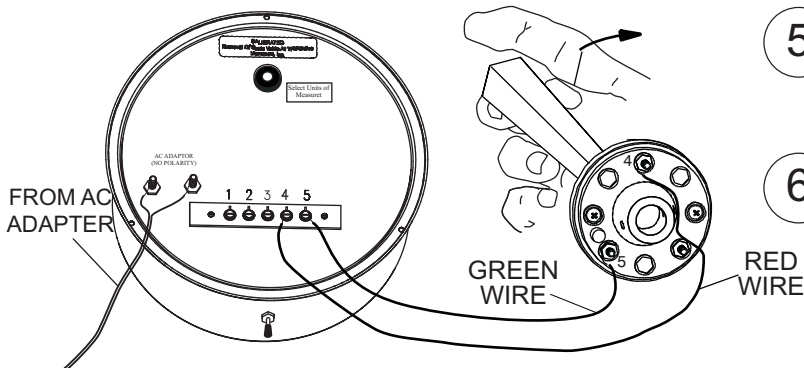

- 5 Remove the sensor from the roof and connect it to the indicator with short pieces of wire.
- 6 Rotate the vane slowly and observe the lights. If it still does not operate properly, then the fault is in the sensor. Otherwise the fault is in the installed wire.

MAXIMUM INC

30 Barnet Boulevard
New Bedford, MA 02745
(508) 995-2200

Page 5

MERLIN

TROUBLE SHOOTING (WIND SPEED)

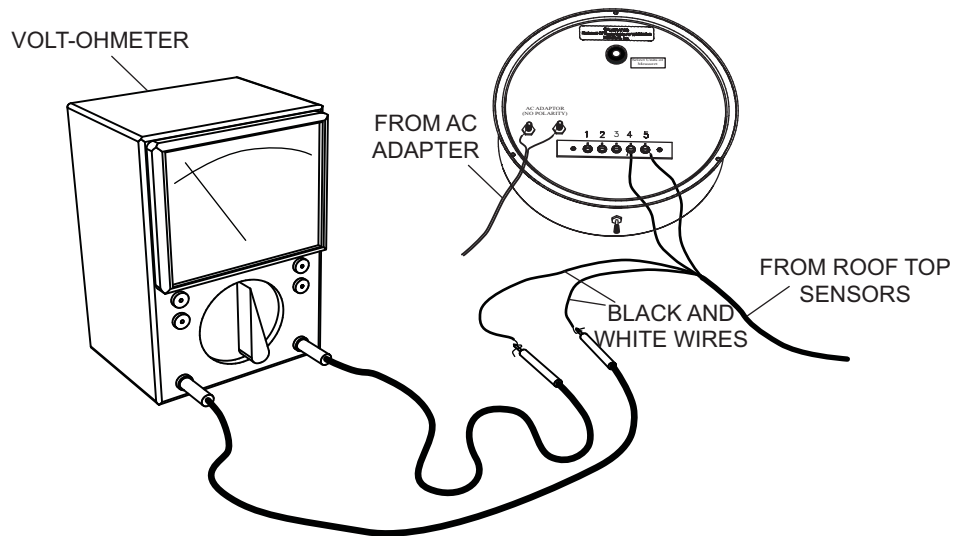

IF THERE IS WIND.....

- 1 Disconnect the black and white wires from the back of the indicator and connect them to volt-ohmmeter as shown. Set for low range AC Volts.
- 2 If the sensor is operating properly, you will achieve these approximate readings:
8-9 MPH = 0.15 VAC rms
17 MPH = 0.31 VAC rms
51 MPH = 0.97 VAC rms
102 MPH = 2.00 VAC rms
- 3 If the sensor delivers the above approximate voltages, then the fault lies in the indicator. If it does not deliver these voltages, then the fault lies in the sensor or installed wire.

IF THERE IS NO WIND.....

- 1 Disconnect the black and white wires from the back of the indicator and connect them to volt-ohmmeter as shown. Set the range for Ohms.
- 2 If the sensor and wire are good, the ohm meter should indicate between 500 and 1,000 ohms. If there is a good reading on the ohm meter, then the indicator is at fault. If the reading is wrong, then the sensor or installed wire is at fault.

MAXIMUM INC

30 Barnet Boulevard
New Bedford, MA 02745
(508) 995-2200

MERLIN

INFORMATION FOR THE MERLIN USER

Warning: Changes or modifications to this unit not expressly approved by the party responsible for compliance could void the user's authority to operate the equipment.

NOTE: This equipment has been tested and found to comply with the limits for a Class B digital device, pursuant to Part 15 of the FCC Rules. These limits are designed to provide reasonable protection against harmful interference in a residential installation. This equipment generates, uses and can radiate radio frequency energy and, if not installed and used in accordance with the instructions, may cause harmful interference to radio communications. However, there is no guarantee that interference will not occur in a particular installation. If this equipment does cause harmful interference to radio or television reception, which can be determined by turning the equipment off and on, the user is encouraged to try to correct the interference by one or more of the following measures:

- Reorient or relocate the receiving antenna.
- Increase the separation between the equipment and receiver.
- Connect the equipment into an outlet on a circuit different from that to which the receiver is connected.
- Consult the dealer or an experienced radio/TV technician for help.

Shielded cables must be used with the wind sensors to ensure compliance with the Class B FCC limits.

MAXIMUM INC

30 Barnet Boulevard
New Bedford, MA 02745
(508) 995-2200

IMPORTANT ADDITIONAL INFORMATION

Components: Along with the indicator, the following components are included with this instrument:

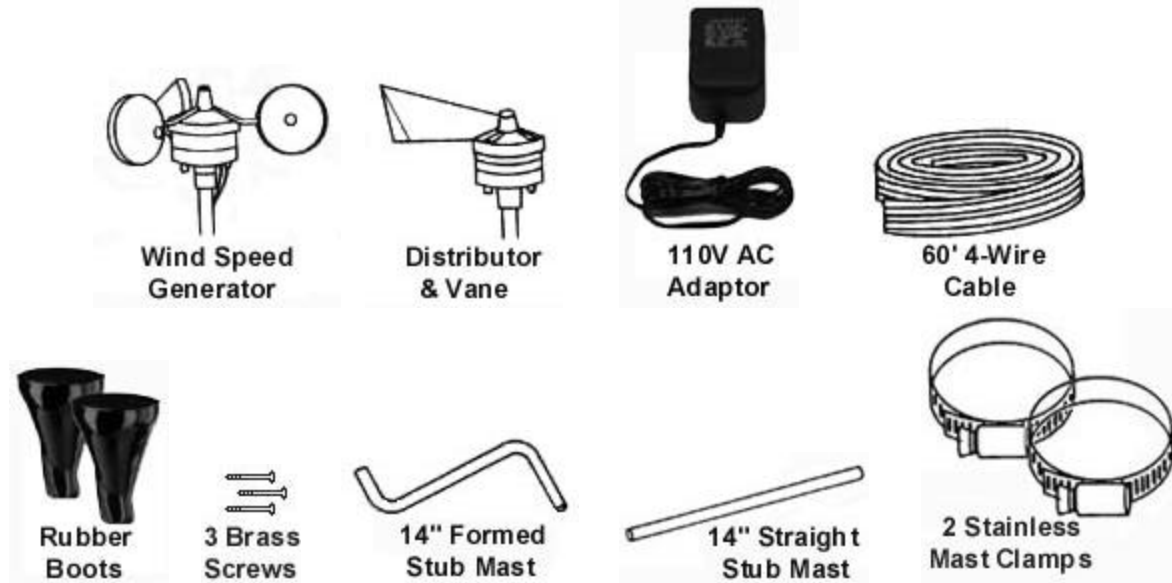

Rooftop sensors: To insure a clear unobstructed path for the wind to the sensors, they should be mounted on some type of antenna mast at least 8-10' above the highest object on your roof. Remember, your roof is also an obstruction and it usually requires at least 8' of height to avoid the turbulence it creates.

AC Adaptor: This instrument requires its own AC Adaptor. Due to the various power requirements of each Maximum instrument, attempting to run more than one instrument on a single adaptor could cause improper operation and/or damage to the instrument(s) thereby voiding your 5-year warranty.

Sensors: Properly installed, your sensors will require virtually no maintenance at all. Our sensors do not utilize brushes or wiping contacts. All bearings are Rulon-J self lubricating type and will perform for many years in the harshest environments.

Brass Case: Your brass case is solid brass A70-30 Holloware quality, with a durable lacquer finish. It is in fact a piece of jewelry and should be treated as such. It should be cleaned at least once a week to keep airborne pollutants (dust, etc...) and any moisture from collecting on the case thereby attacking the lacquer. At no time should you use an abrasive cleaner or cloth on the brass case. Simply use a soft cloth or soft paper towel with a mild glass cleaner to wipe the case clean. If your instruments are in a summer home, and you are not able to clean them regularly, simply lay a small cloth or towel across the top two-thirds so that dust cannot settle on the finish.

Specifications: All instrumentation or measuring devices have accuracy tolerances and specifications. Making comparisons between different pieces of equipment is appropriate provided the specified accuracies of both are known.

	Measurement Range	Guaranteed Accuracy
Wind Speed	0-255 MPH	±2% Full Scale & Mid Scale
Wind Direction (Indicator)	16 Compass Points	Zero Error (Digital Display System)
Wind Direction (Sensor)		±11.25 Degrees



Electrical Damage – Common Causes & Recommended Prevention

Electrical damage can be caused by many different factors. Below are some of the more common causes and some suggested methods of minimizing potential problems.

Common Causes:

- **Storm Activity** – lightening in your area can do damage to your instruments in different ways. The obvious way is due to a direct or nearby strike. In addition, lightening storms, dust storms, dry snowstorms and strong dry winds can all cause static electricity to build up on and around your external sensors. Regardless of the cause this built up electricity can discharge itself through the cable connecting the external sensors to the instrument.
- **Power Surges** – A surge may come from the electric company's switching generators or power grids, from local industries or after power interruption when accumulated power suddenly surges back through AC lines. Even the on-and-off switching of large electrical appliances, such as refrigerators or clothes dryers can create damaging fluctuations. This is especially true with sensitive weather recording devices.
- **Yourself** – Are you constantly giving and/or receiving a shock every time you touch a doorknob or another person? If so you have a great deal of static electricity in your environment. Depending on where you live, static electricity may be a year round problem or only a seasonal problem. In either case, it is possible for a person to carry enough of a charge to damage an instrument.

Recommended Prevention:

Ground Your Mounting Mast – *IMPORTANT: PVC and fiberglass are not recommended mast materials as they can store high amounts of static electricity within themselves.* It is recommended that you follow the grounding instructions that came with your mounting mast, while also maintaining accordance to your local Electric Code. In the absence of instructions for your mast system, the following generic guidelines from the **National Electric Code** may be helpful.

- 1) The NEC requires that the antenna mast and mount be grounded directly. No splices or connections are allowed in the ground wire between the mast and the ground rod.
 - 2) Attach one end of a No. 8 (or thicker) copper or aluminum ground wire to the antenna mast. **Note:** As static electricity issues are more common for weather sensors than direct lightening strikes, consider installing the ground wire as physically close to the wind sensors as possible to best combat static electricity issues. For multi-piece (or telescoping) masts, consider connecting the ground to each separate section of the mast.
 - 3) For painted or coated masts, scrape off the coating around the area where the contact will be made. This will ensure a good, solid connection. (Once the ground is attached to the mast, any scraped off portion that is exposed should be recoated with paint or other sealant.)
 - 4) Next, run the ground wire to ground as directly as possible. Standard wire staples can be used to secure the ground wire against the side of the house. Avoid making 90° or sharper turns with the ground wire. A lightning charge has difficulty making such a turn and therefore may discharge into the house. Make ground wire bends as smooth and as gradual as possible.
 - 5) The ground wire must be connected to a ground rod. Water pipes or plumbing fixtures are not acceptable. A good copper-coated steel ground rod driven at least 3 feet into the ground is required. Special clamps that provide a solid connection between the ground wire and ground rod should be used
- **Use Surge Protectors** – For the AC adapter, a UL 1449 rated surge protector with EMI/RFI filtering is recommended. This rating will be clearly listed on the packaging of any good quality surge protector.
 - **Discharge Yourself** – If the instruments are located in an environment where static electricity is a problem, make sure that you discharge yourself before touching the instrument(s). The shock that you get from touching a doorknob or another person can often be sufficient to damage an instrument.